

2023 GAIA ULTIMATE CUP~GLOVE TOURNAMENT~
Qualifying tournament

A tournament

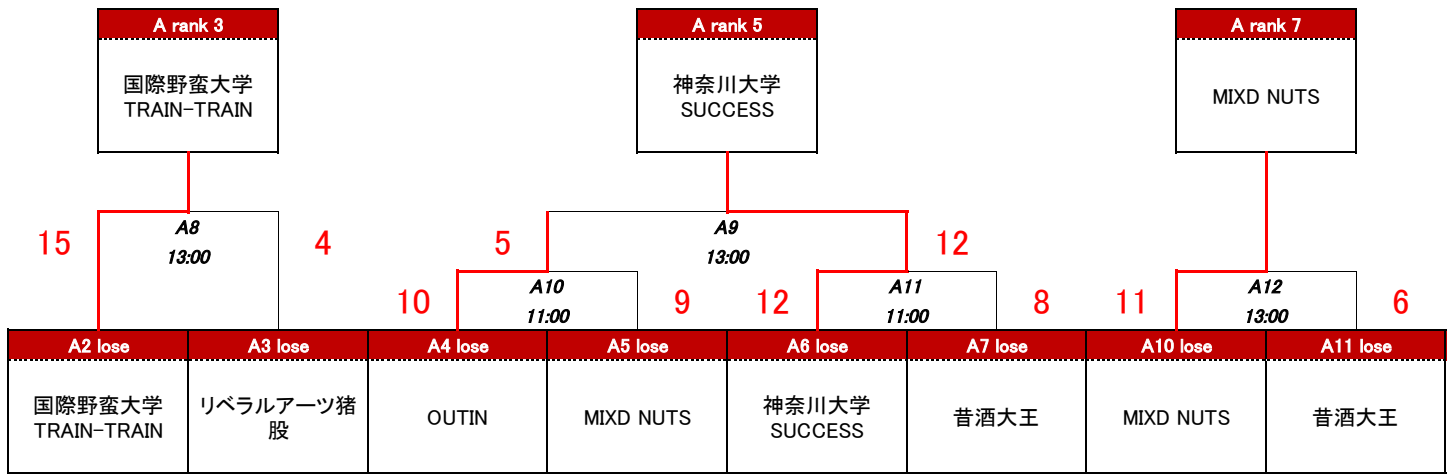

B tournament

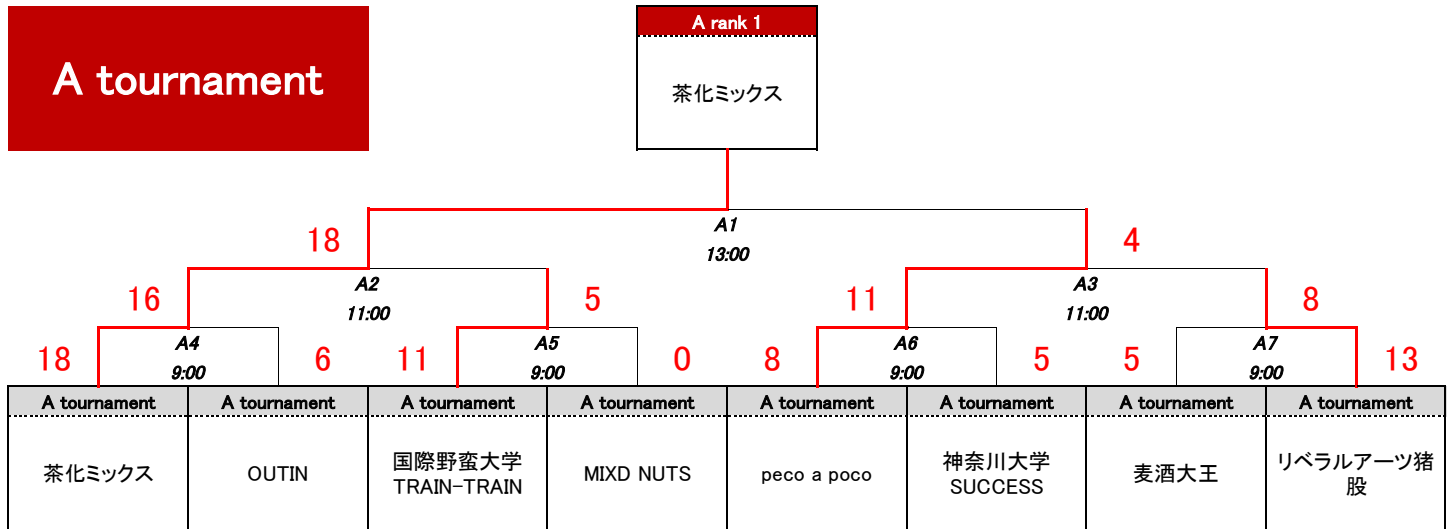
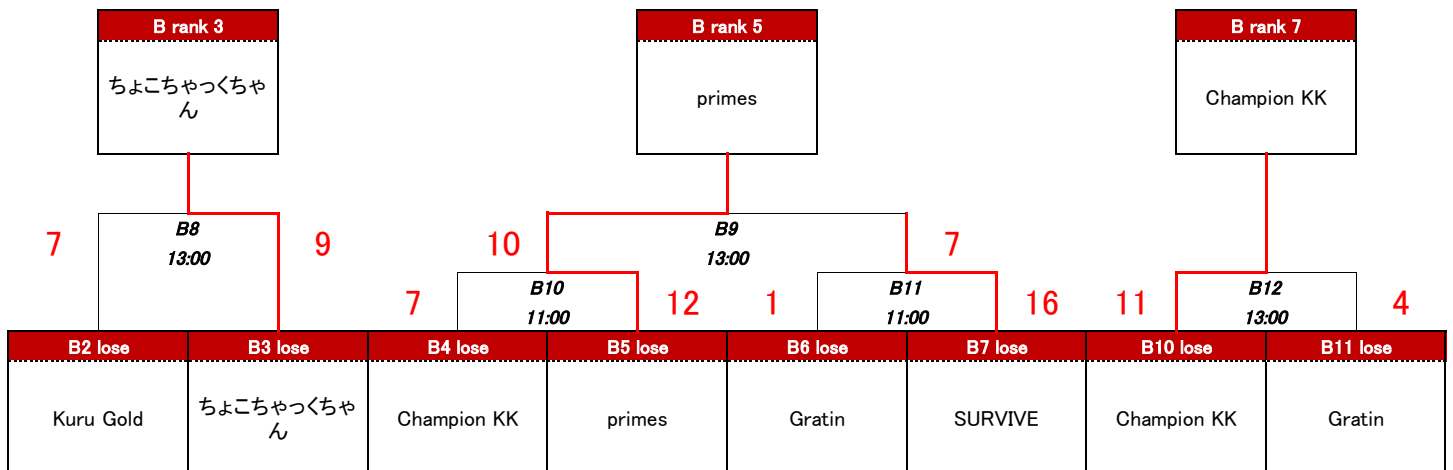
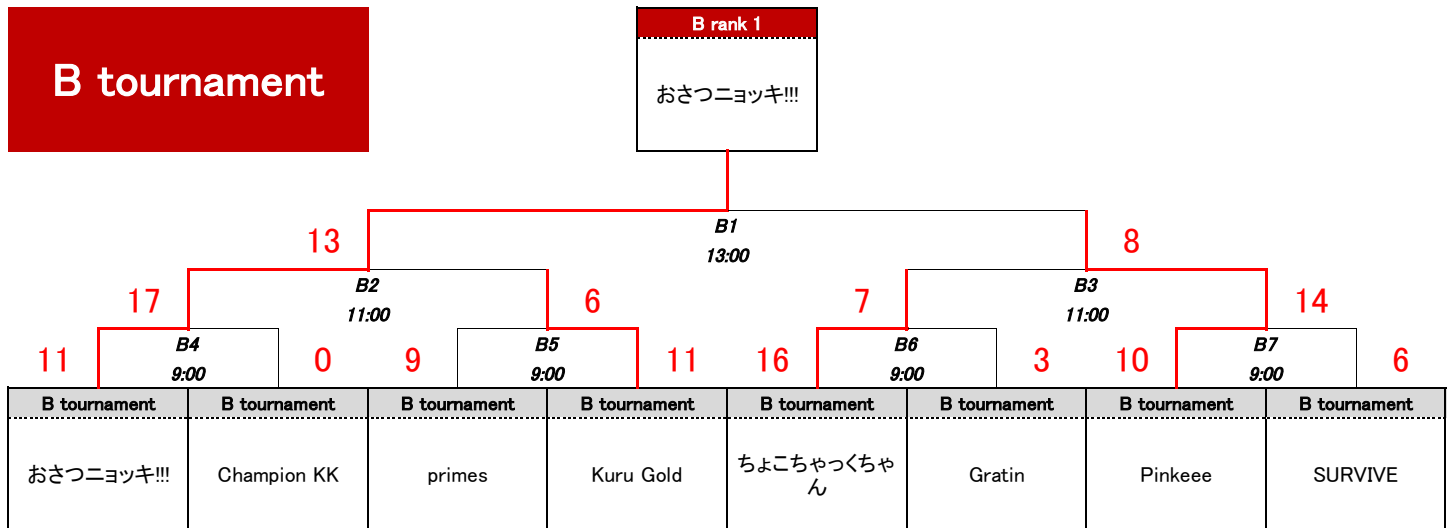

2023 GAIA ULTIMATE CUP~GLOVE TOURNAMENT~
Qualifying tournament

C tournament

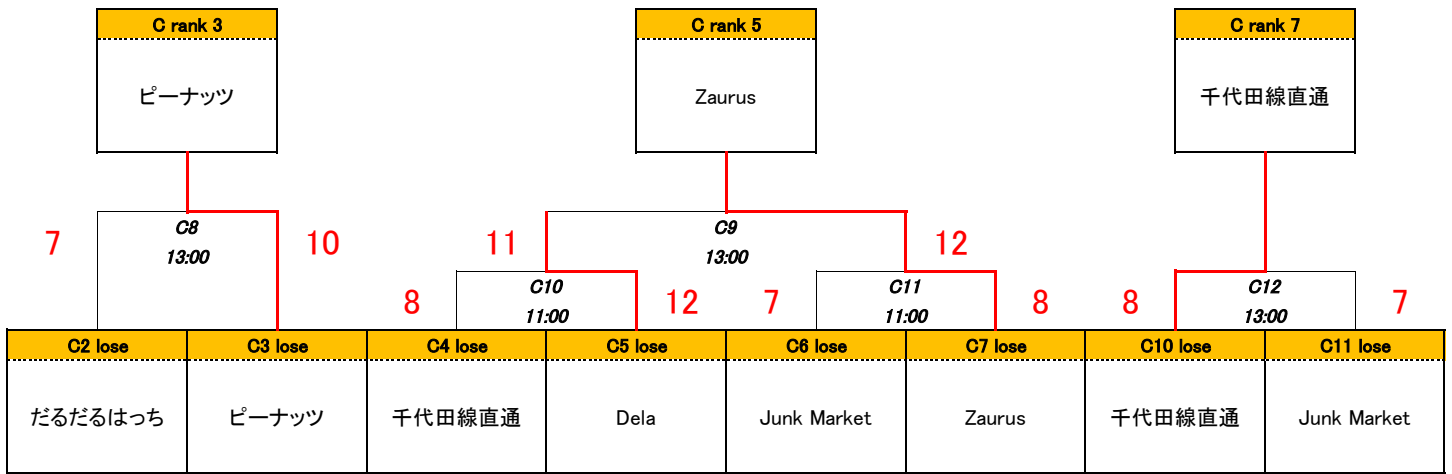
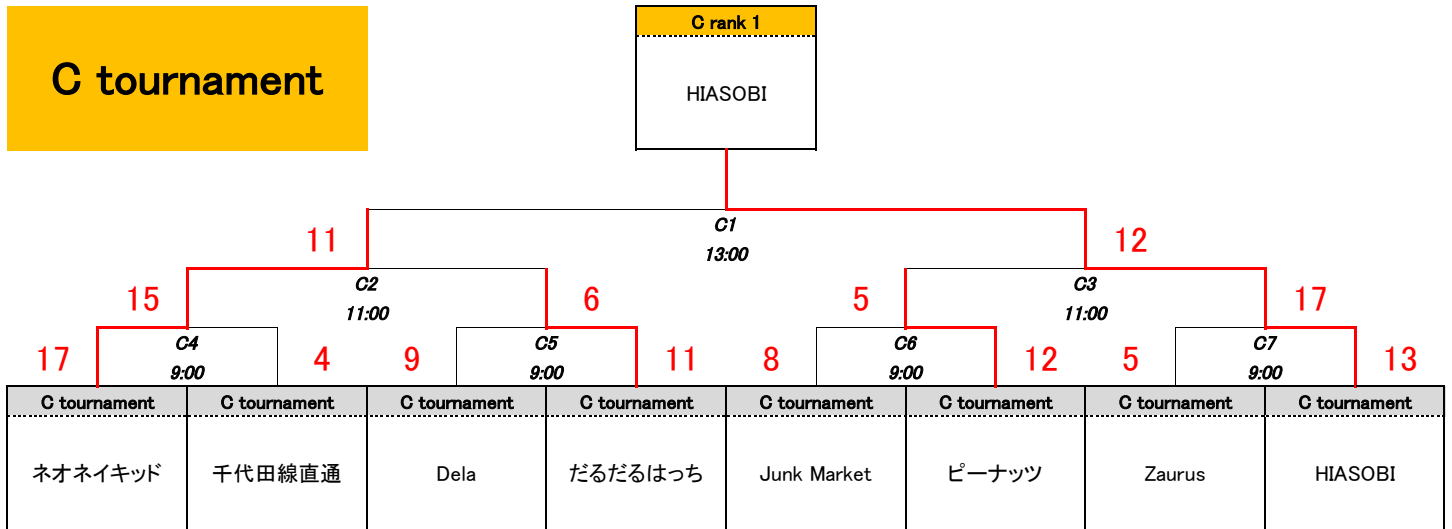

D tournament

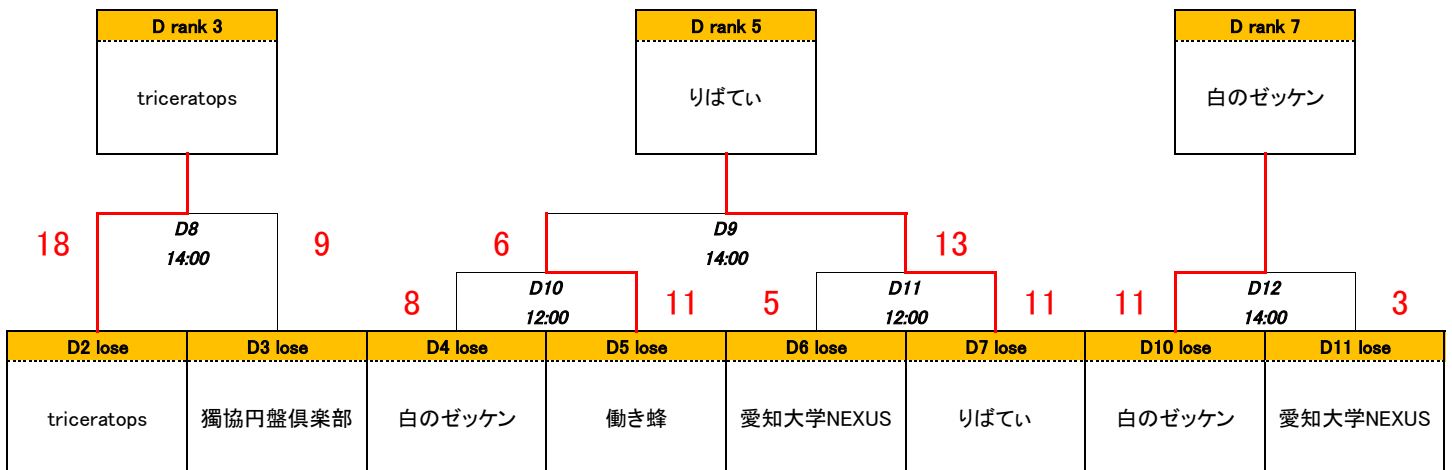
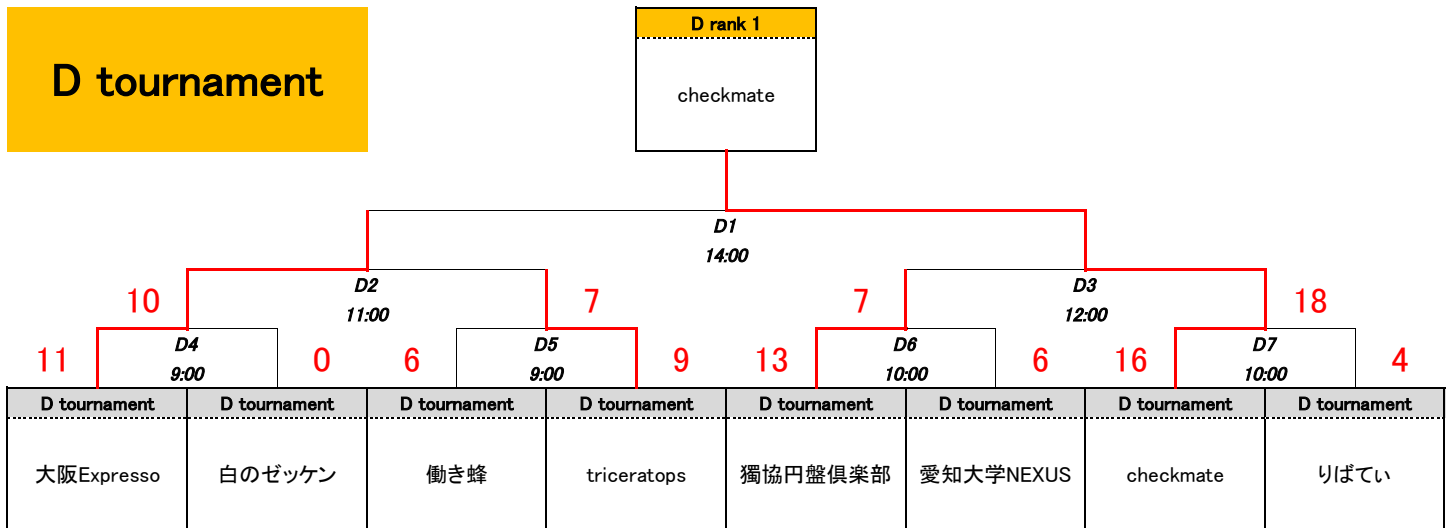

2023 GAIA ULTIMATE CUP~GLOVE TOURNAMENT~
Qualifying tournament

E tournament

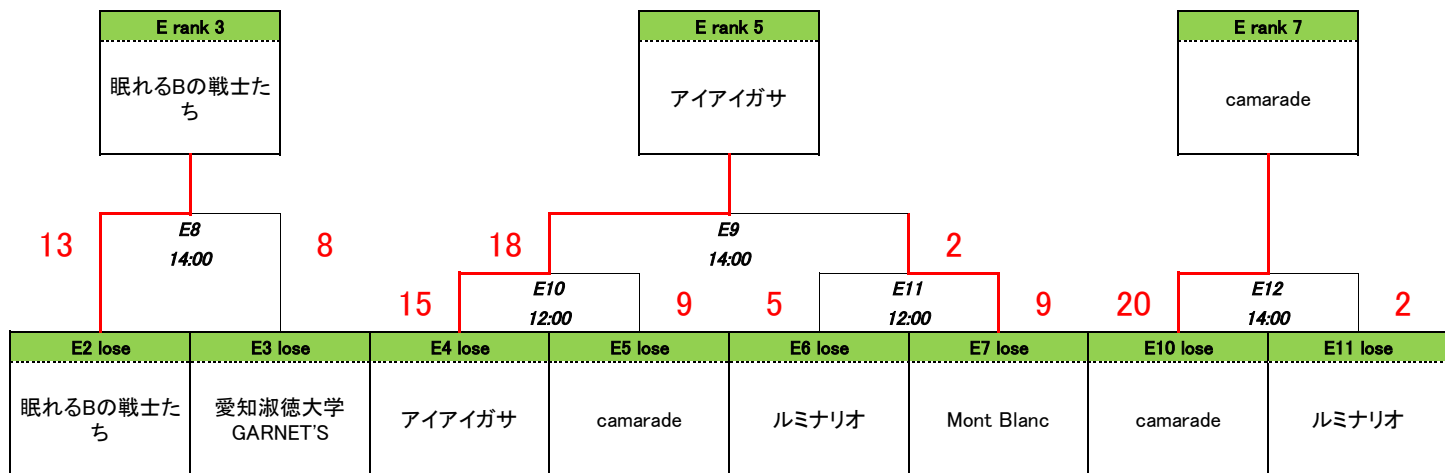
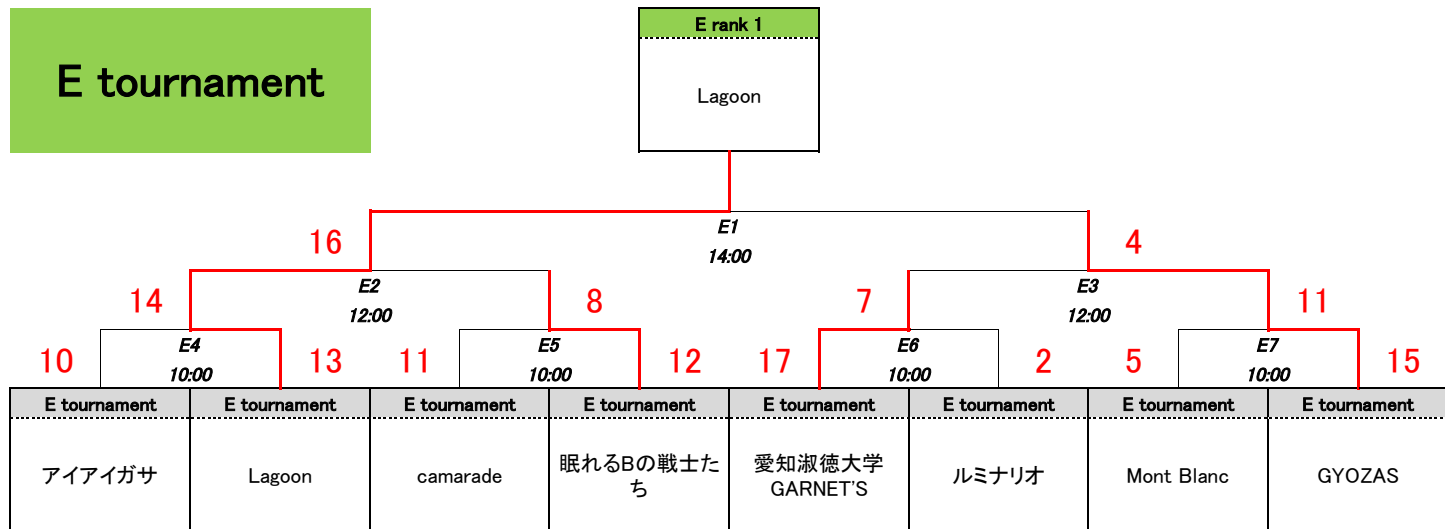

F tournament

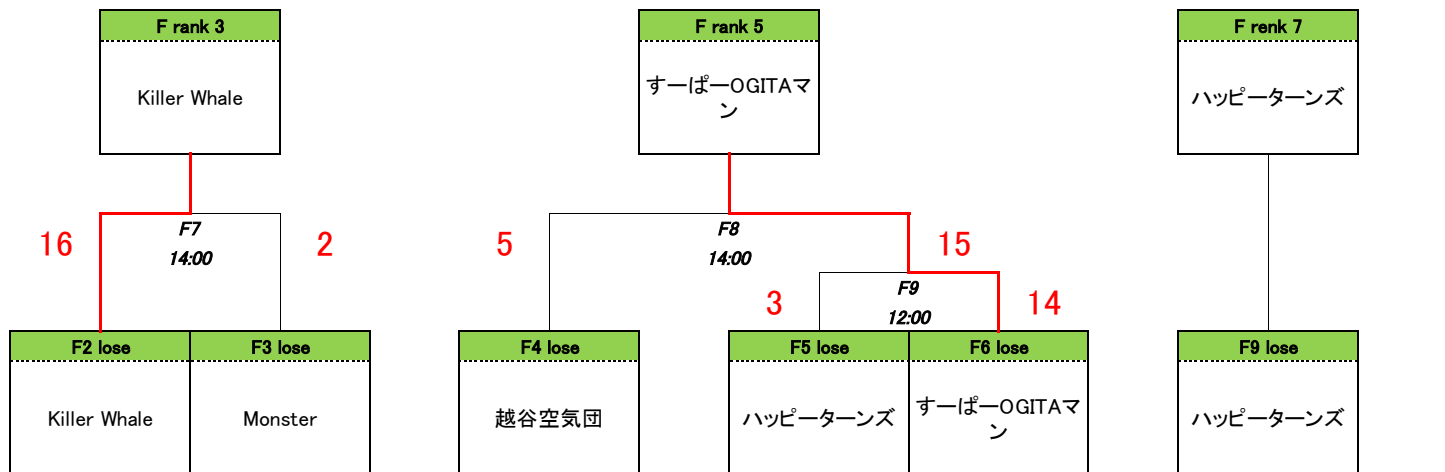
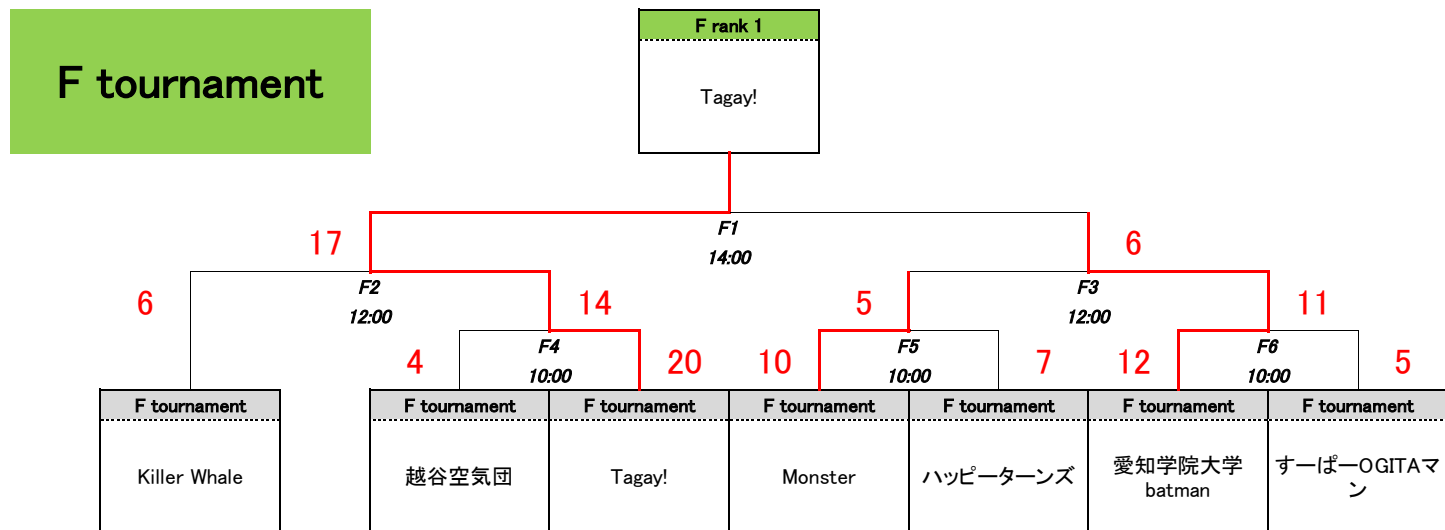

2023 GAIA ULTIMATE CUP~GLOVE TOURNAMENT~
Qualifying tournament

G tournament

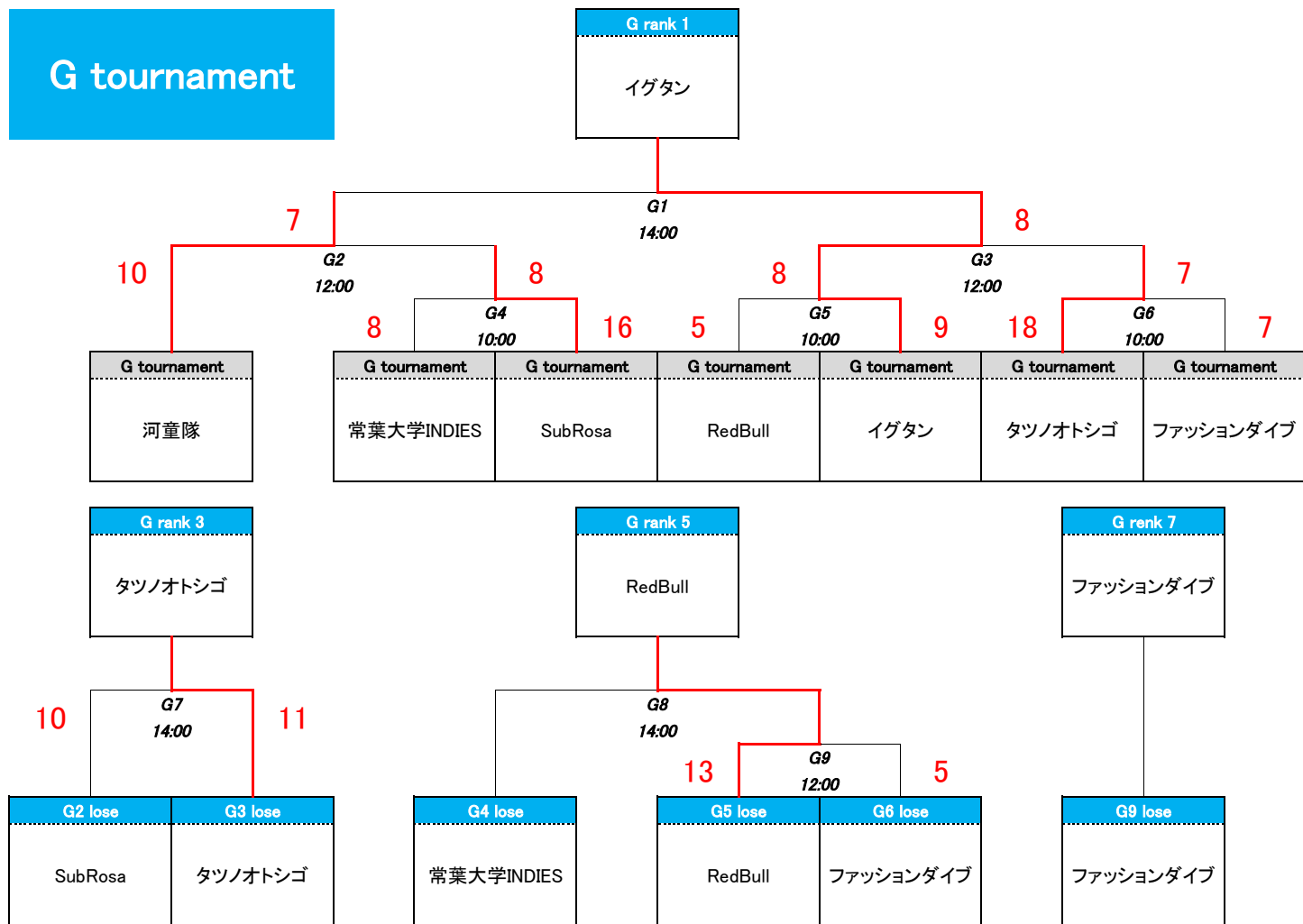

H tournament

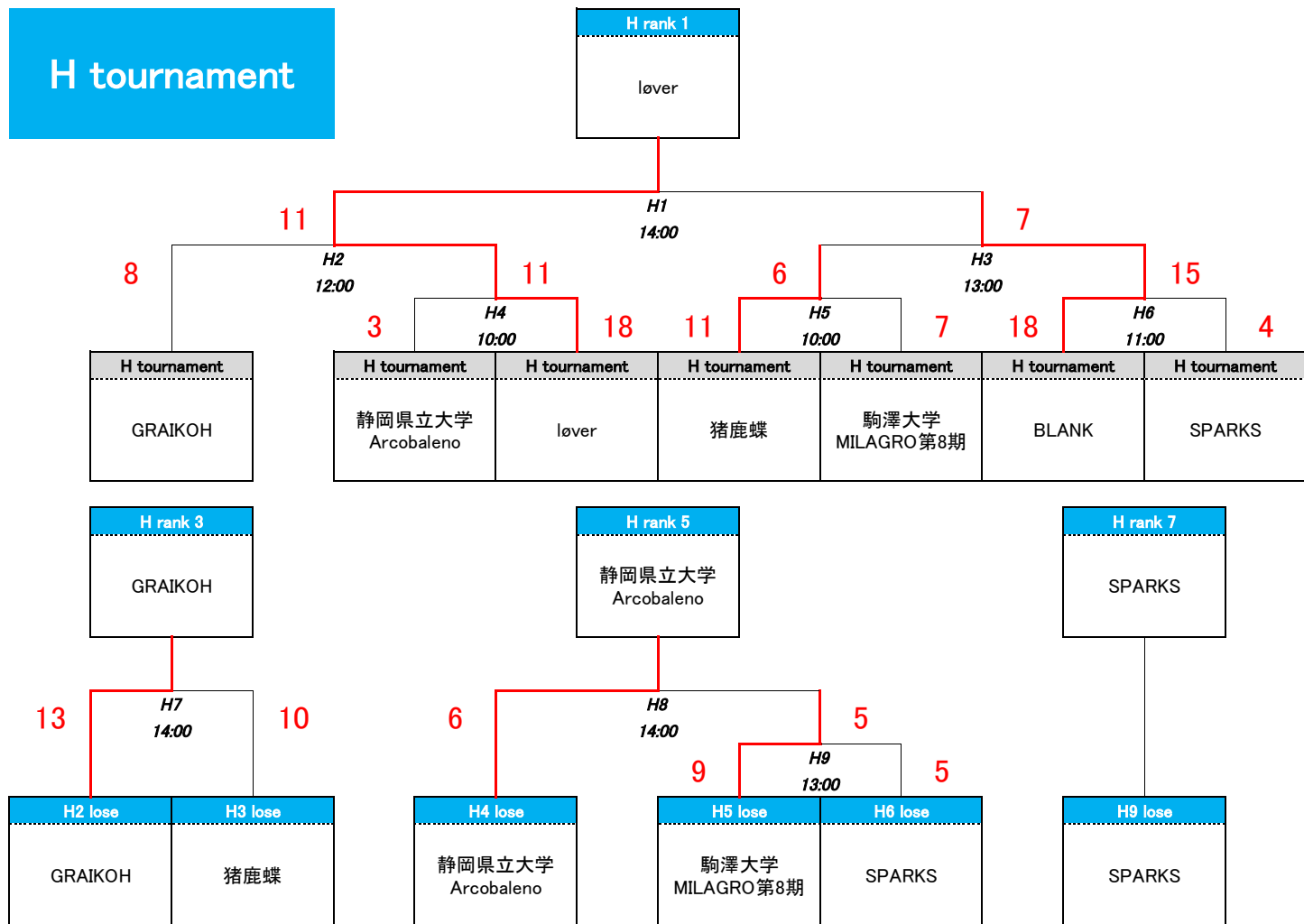

2023 GAIA ULTIMATE CUP~GLOVE TOURNAMENT~
Championship tournament

Championship tournament

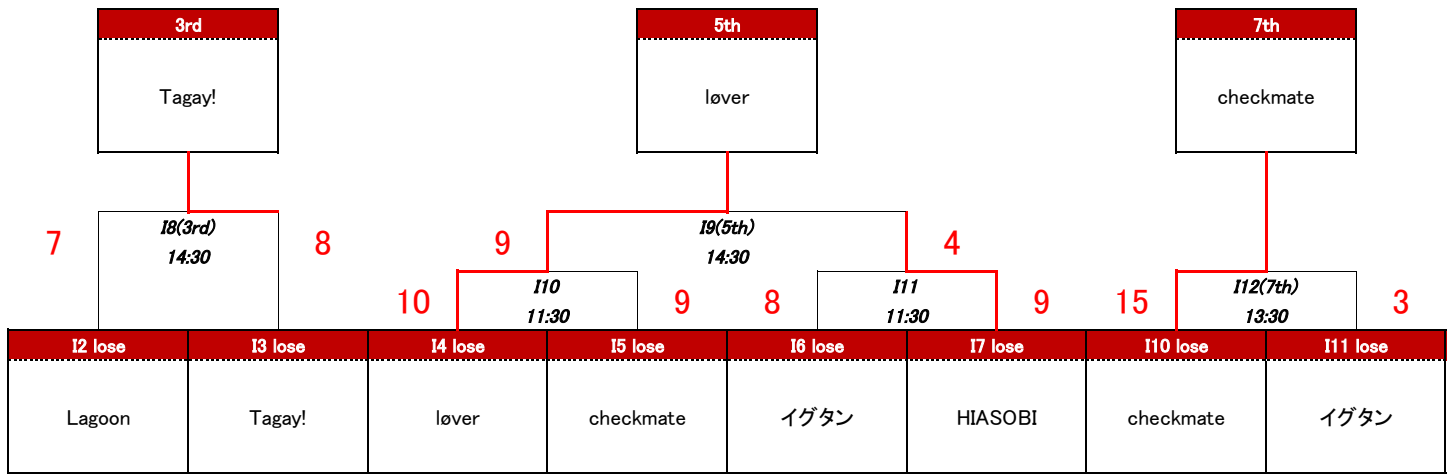
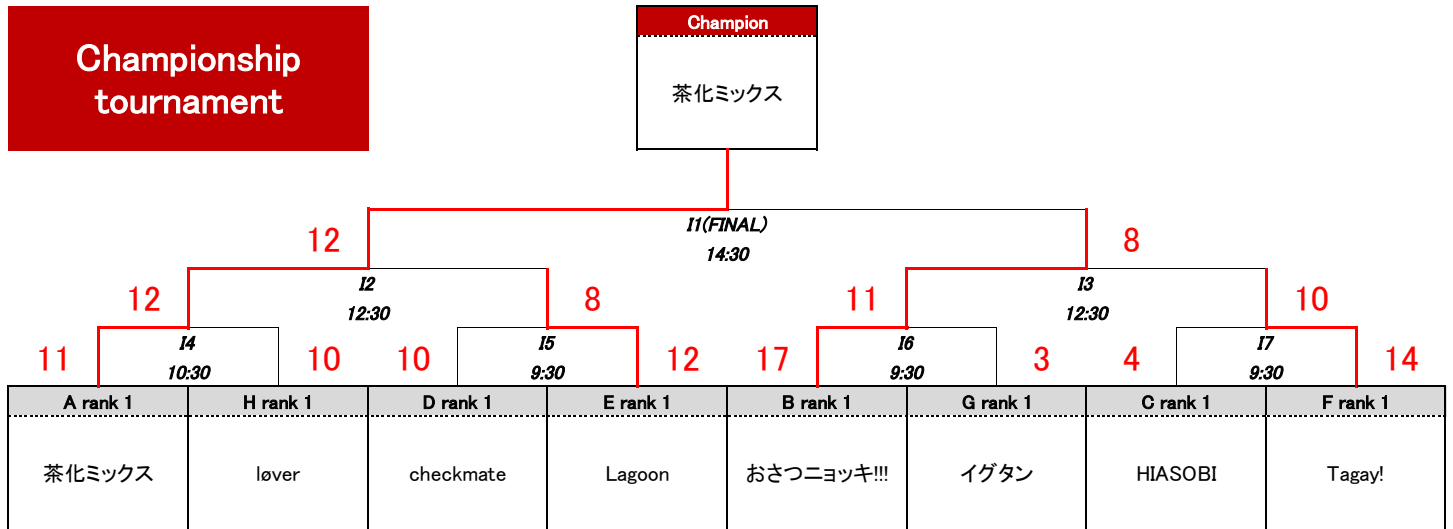

9th placement tournament

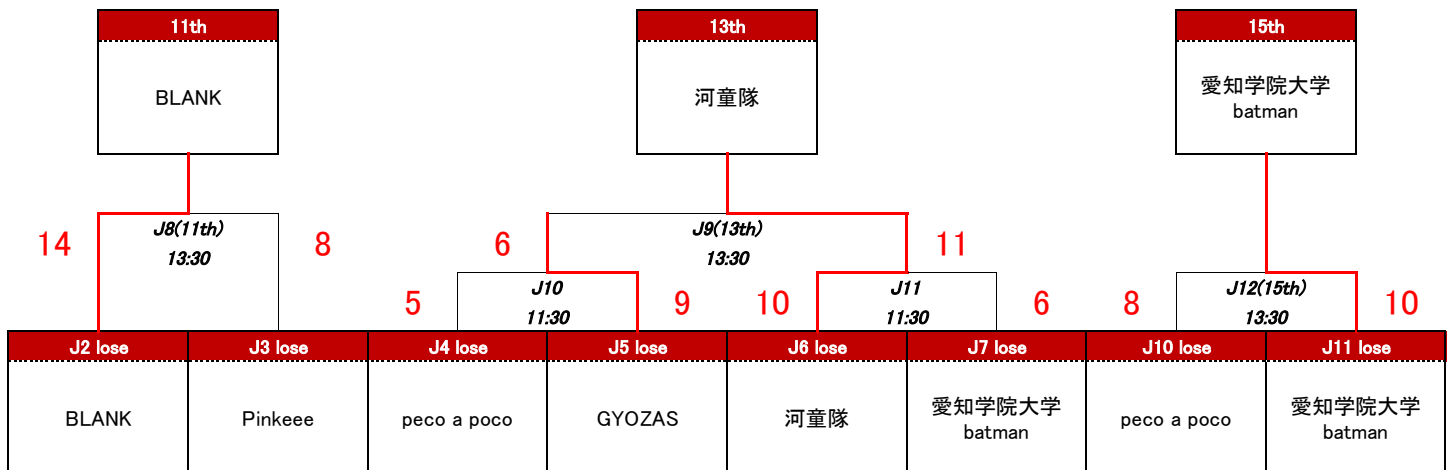
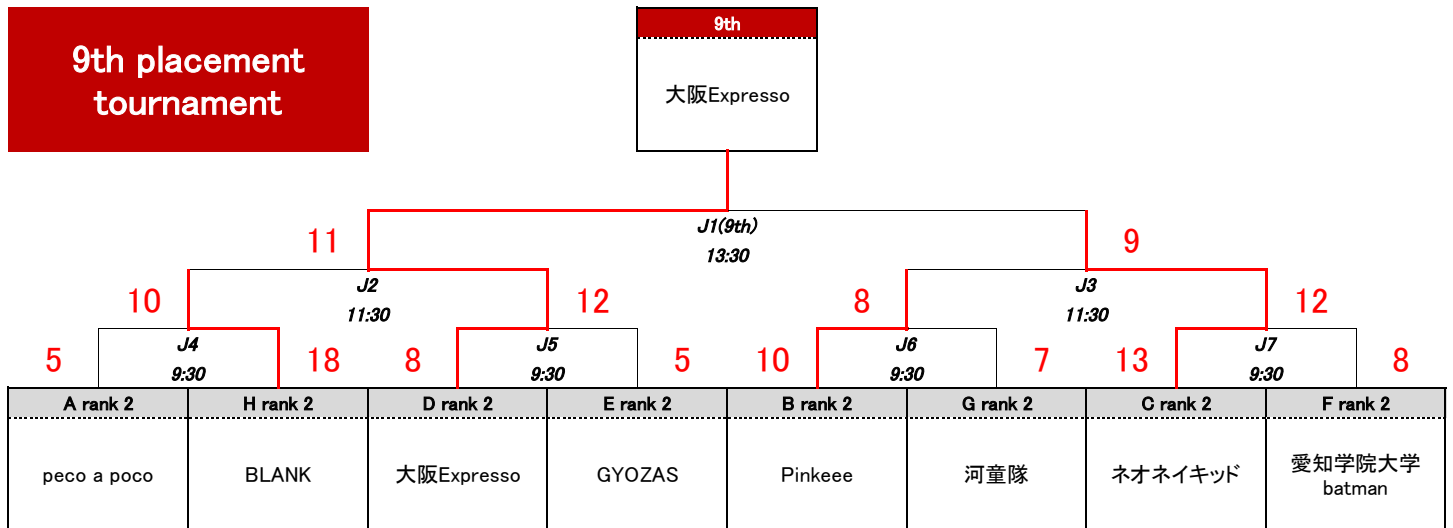

2023 GAIA ULTIMATE CUP~GLOVE TOURNAMENT~
Championship tournament

17th placement tournament

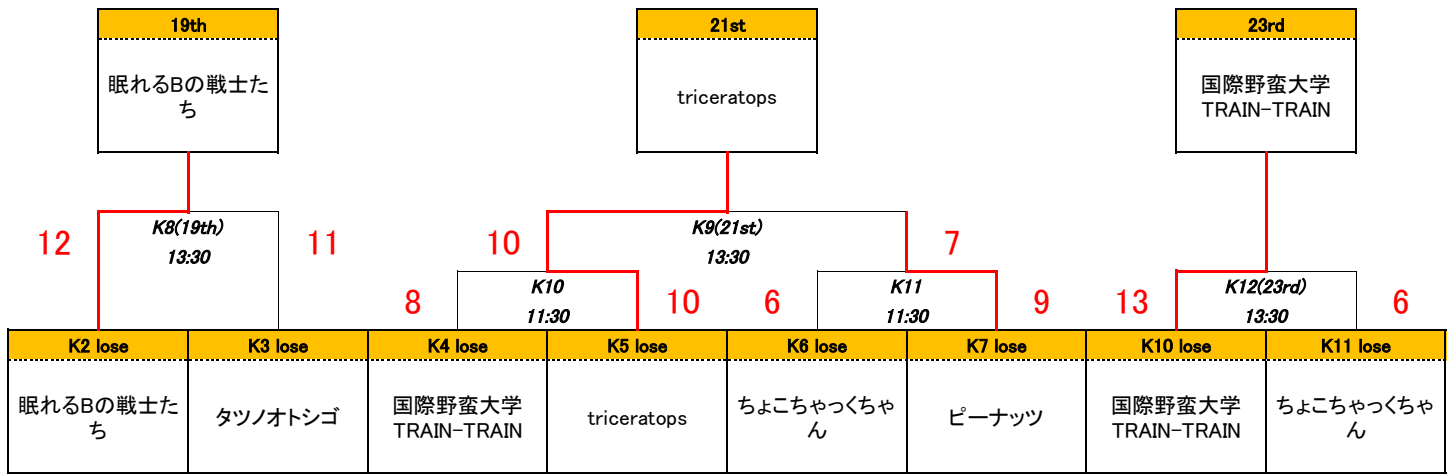
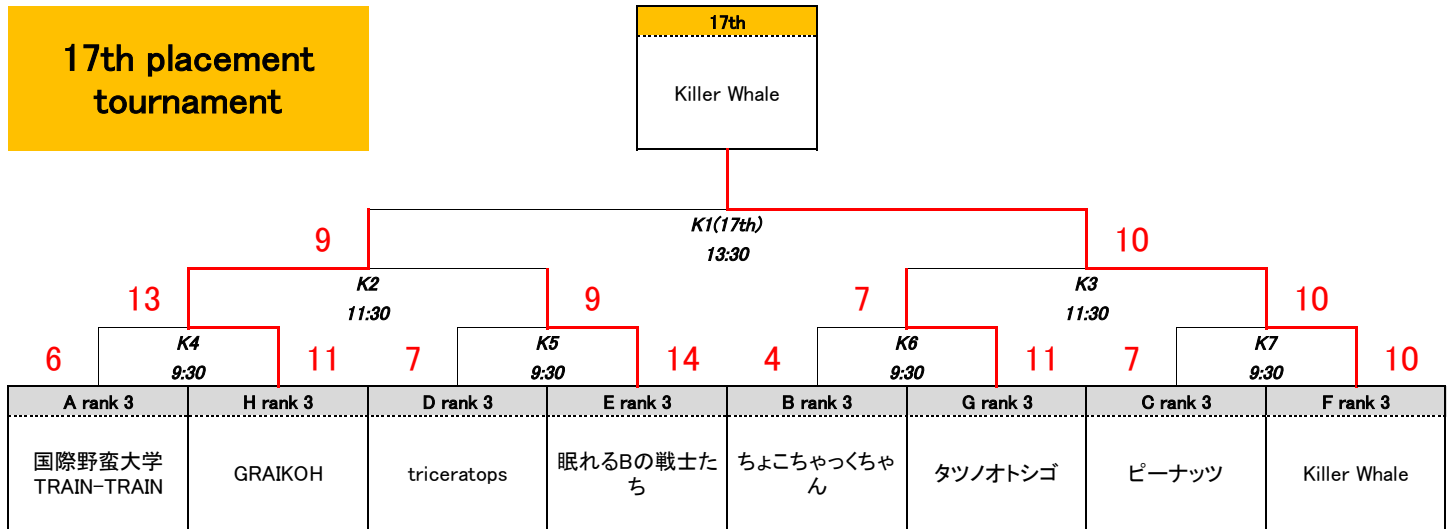

25th placement tournament

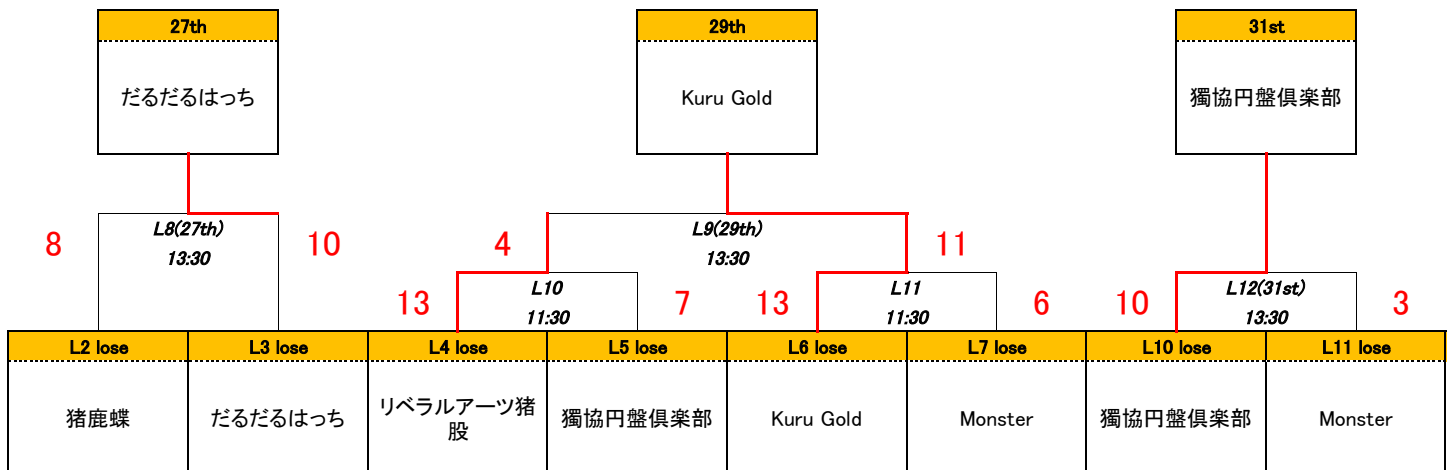
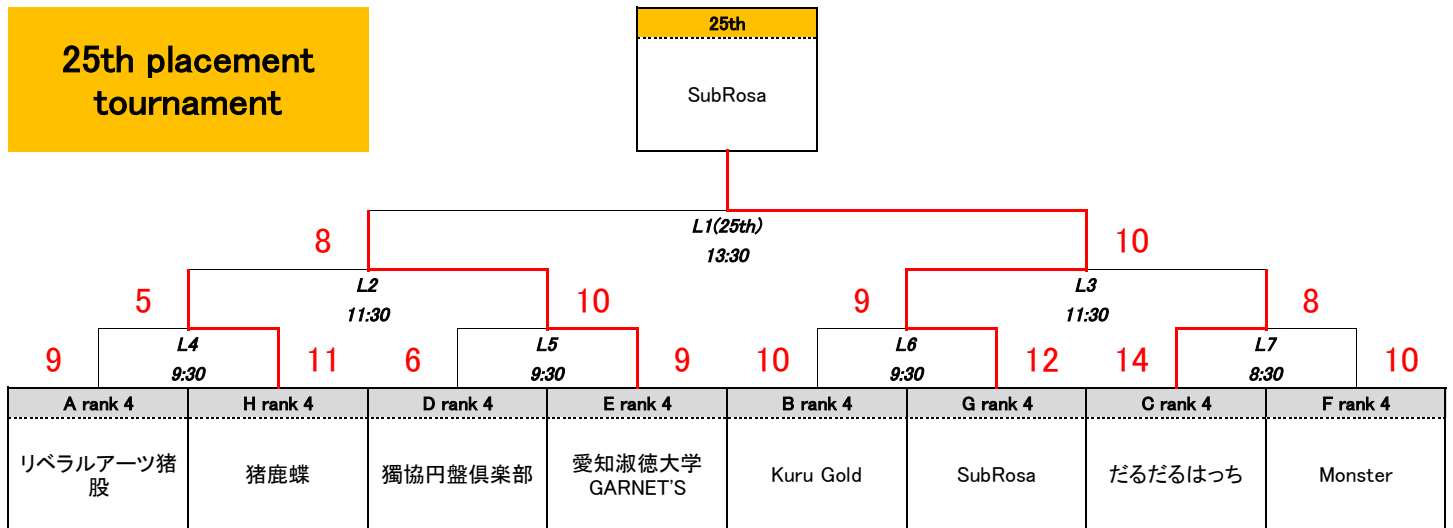

2023 GAIA ULTIMATE CUP~GLOVE TOURNAMENT~
Championship tournament

33rd placement tournament

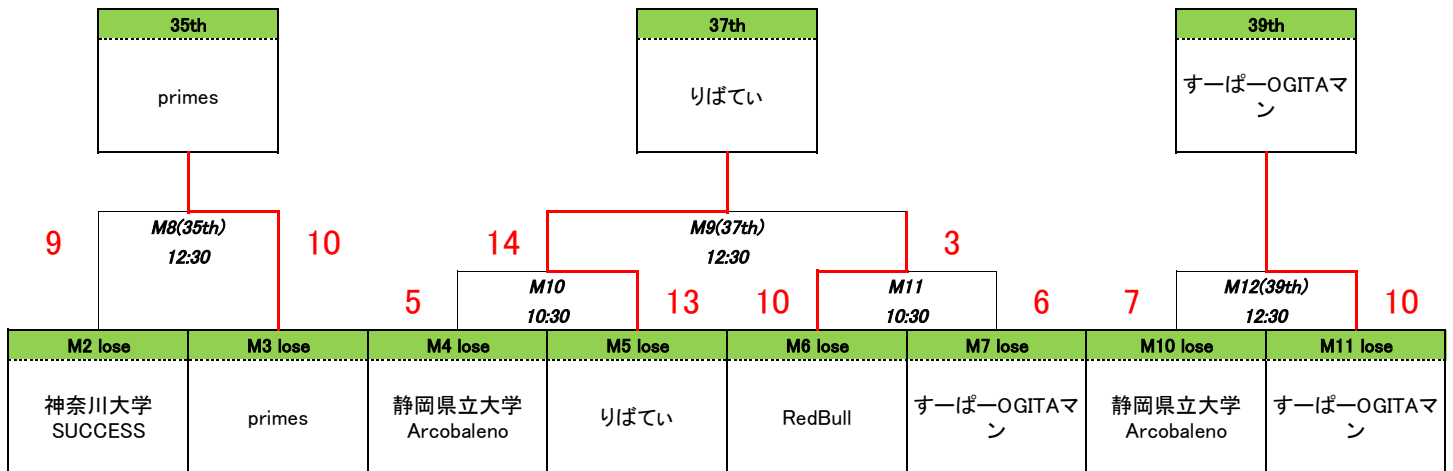
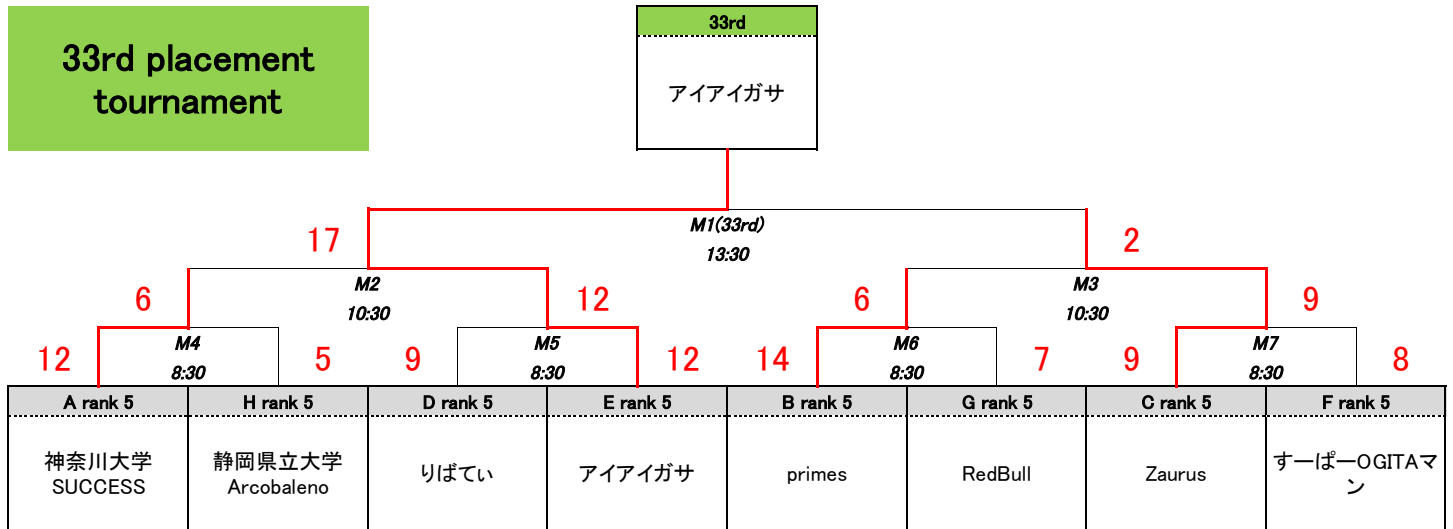

41st placement tournament

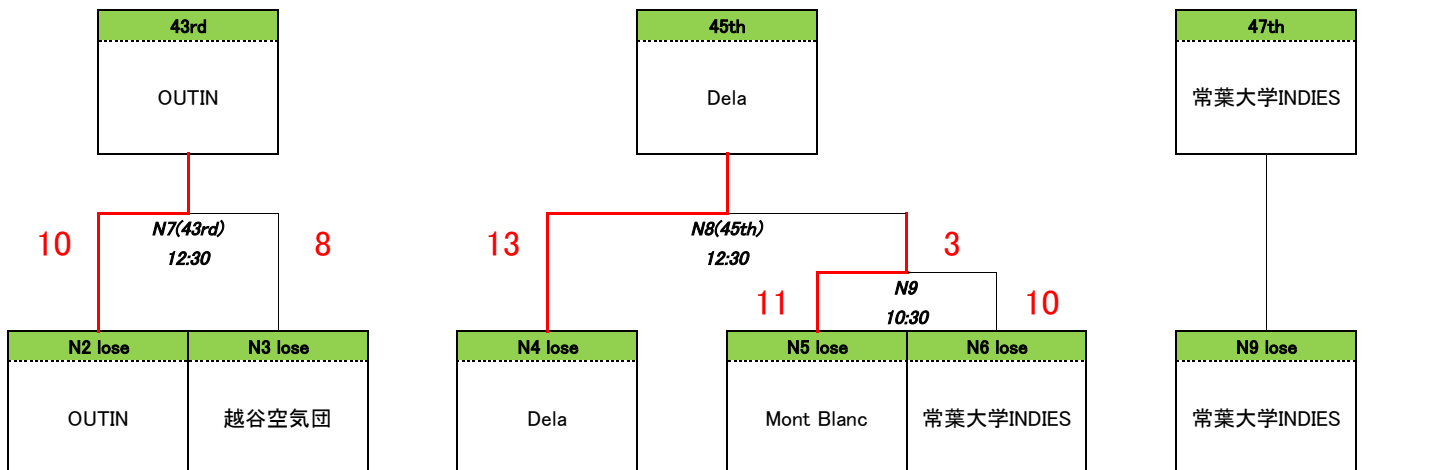
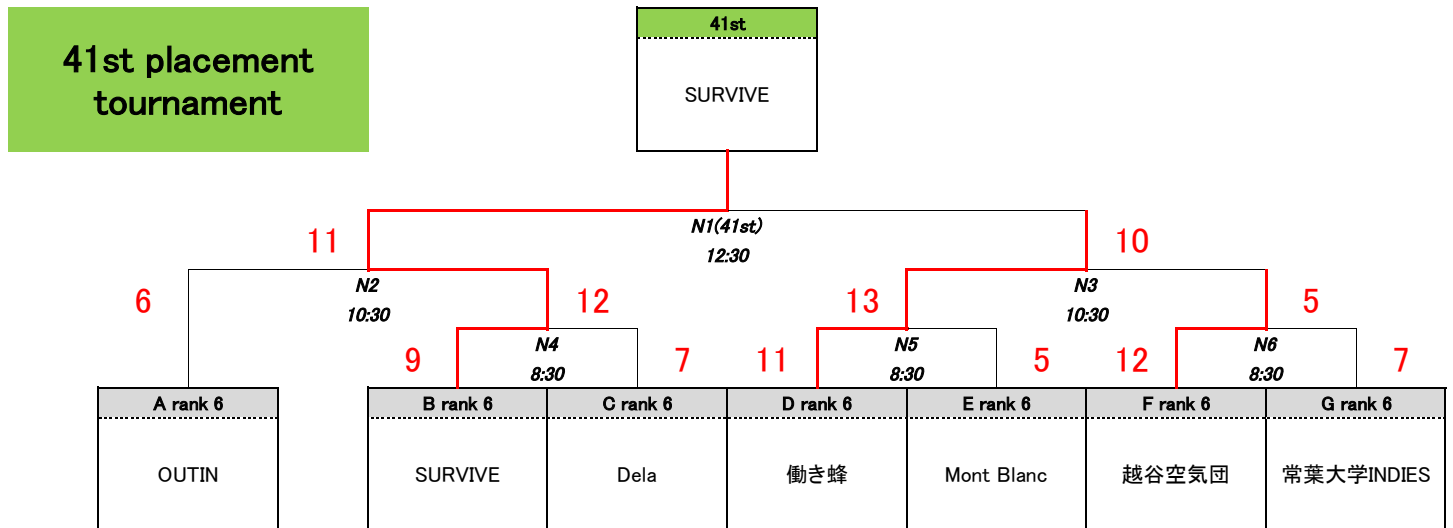

2023 GAIA ULTIMATE CUP~GLOVE TOURNAMENT~
Championship tournament

48th placement tournament

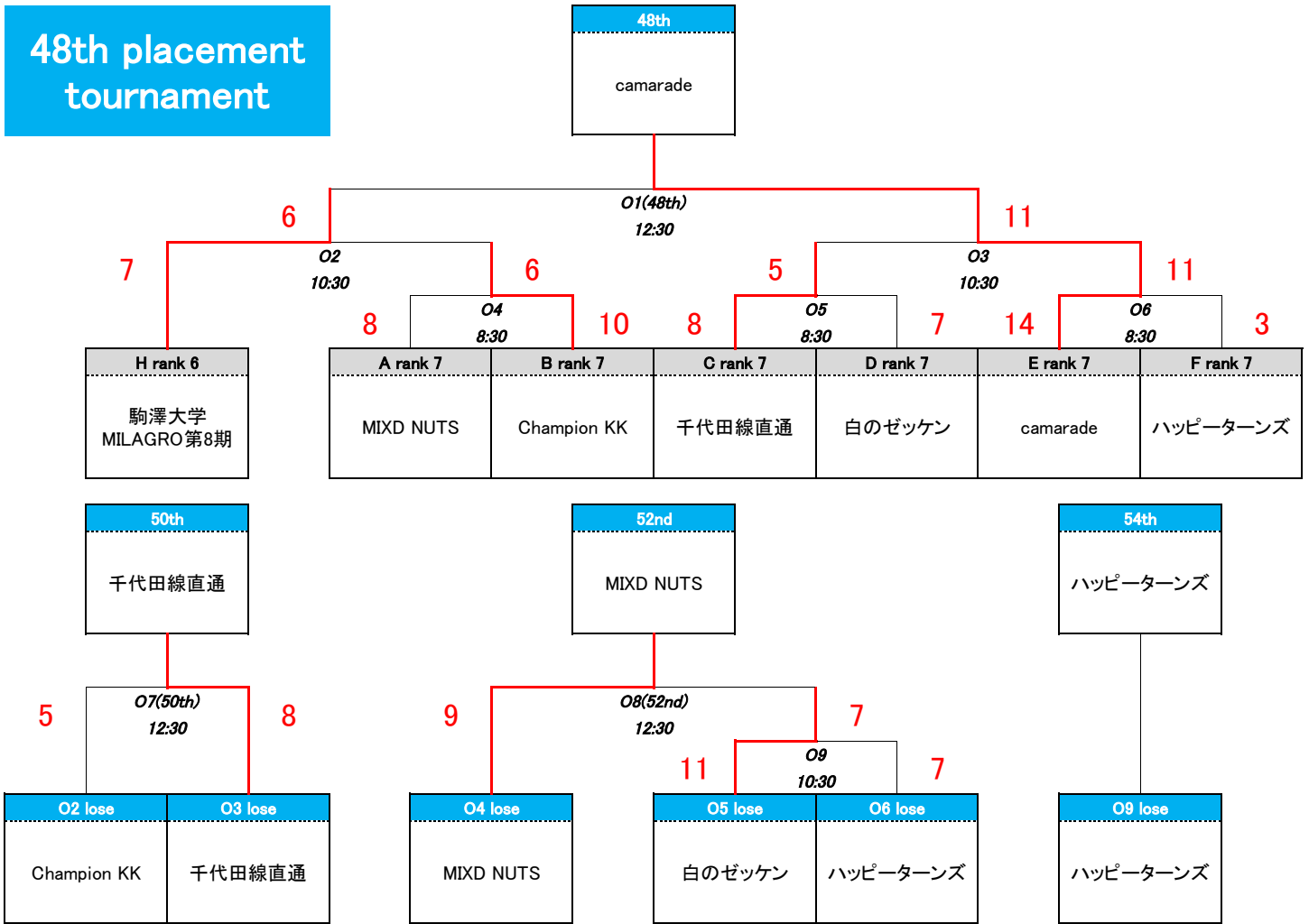

55th placement tournament

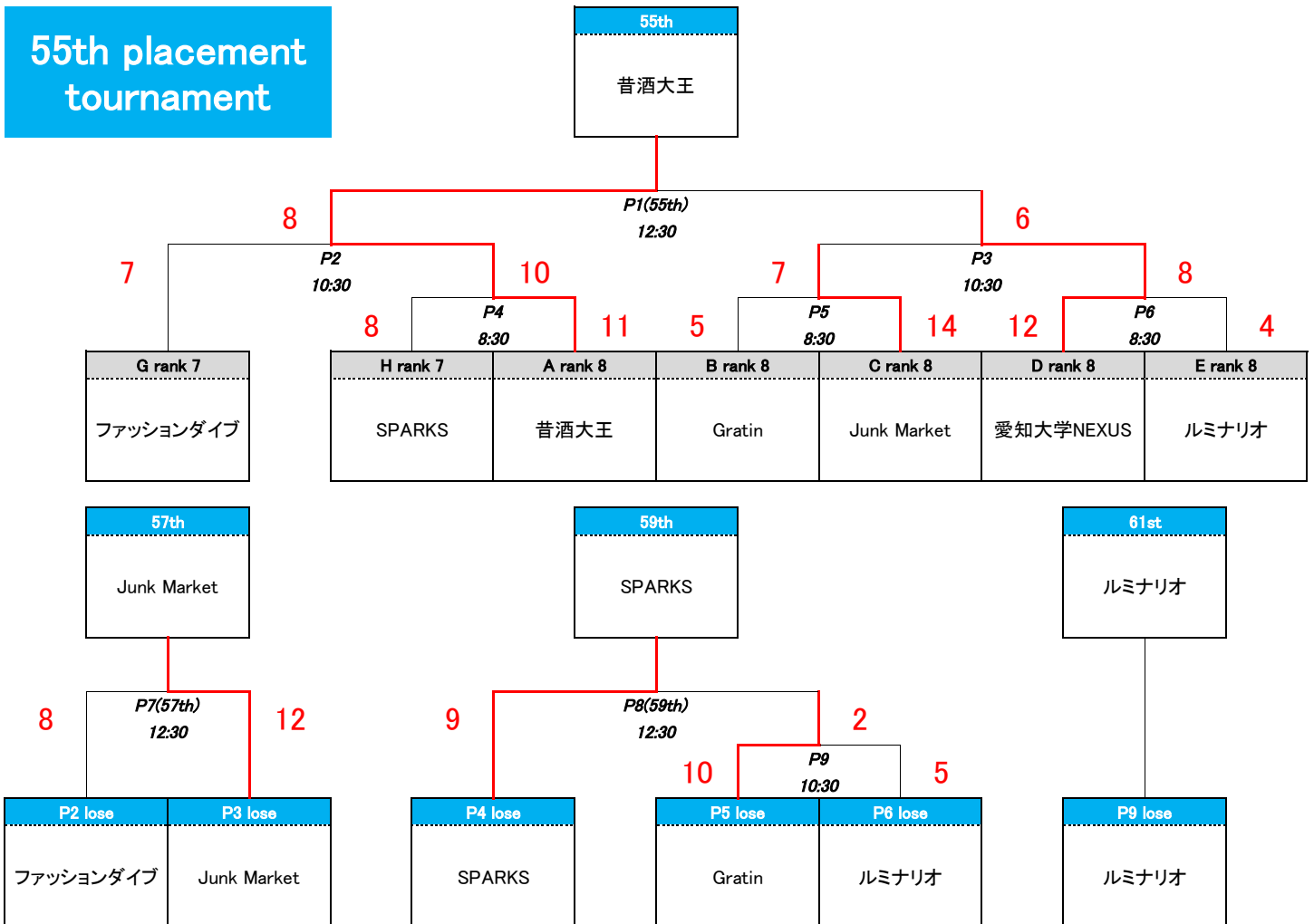

2023 GAIA ULTIMATE CUP~GLOVE TOURNAMENT~

FINAL RESULT

Rank	Team name	Rank	Team name	Rank	Team name	Rank	Team name
1st	茶化ミックス	17th	Killer Whale	33rd	アイアイガサ	49th	駒澤大学MILAGRO 第8期
2nd	おさつニヨッキ!!!	18th	GRAIKOH	34th	Zaurus	50th	千代田線直通
3rd	Tagay!	19th	眠れるBの戦士たち	35th	primes	51st	Champion KK
4th	Lagoon	20th	タツノオトシゴ	36th	神奈川大学SUCCESS	52nd	MIXD NUTS
5th	løver	21st	triceratops	37th	りばてい	53rd	白のゼッケン
6th	HIASOBI	22nd	triceratops	38th	RedBull	54th	ハッピーターンズ
7th	checkmate	23rd	国際野蛮大学TRAIN- TRAIN	39th	すーぱーOGITAMAN	55th	昔酒大王
8th	イグタン	24th	ちょこちゃっくちゃん	40th	静岡県立大学 Arcobaleno	56th	愛知大学NEXUS
9th	大阪Expresso	25th	SubRosa	41st	SURVIVE	57th	Junk Market
10th	ネオネイキッド	26th	愛知淑徳大学 GARNET'S	42nd	働き蜂	58th	ファッションダイ ブ
11th	BLANK	27th	だるだるはっち	43rd	OUTIN	59th	SPARKS
12th	Pinkeee	28th	猪鹿蝶	44th	越谷空気団	60th	Gratin
13th	河童隊	29th	Kuru Gold	45th	Dela	61st	ルミナリオ
14th	GYOZAS	30th	リベラルアーツ猪股	46th	Mont Blanc		
15th	愛知学院大学 batman	31st	獨協円盤倶楽部	47th	常葉大学INDIES		
16th	peco a poco	32nd	Monster	48th	camarade		
Rank	Individual award						
MVP	大橋 伸将 選手(茶化ミックス 所属)						
Fighting-spirit award	西村 真歩 選手(おさつニヨッキ!!! 所属)						